

	Model type
	M
H (mm)	679
B (mm)	900
T (mm)	450
T1 (mm)	880
Doors	2
Tare weight (kg)	27
Inside cabinet volume (m <sup>3</sup> )	0,30

### Outer dimensions

This drawing is our property!  
Furnish this information to other persons and reproduce or copy is not permitted without our written permission.

title: Safety cabinet  
ACID UTS PP

drawing no.: 000104721

page: 1 of 4

revision: 00

date: 2020-03-04

Düperthal Sicherheitstechnik  
Frankenstrasse 3  
D-63791 Karlstein

 **DÜPERTHAL**



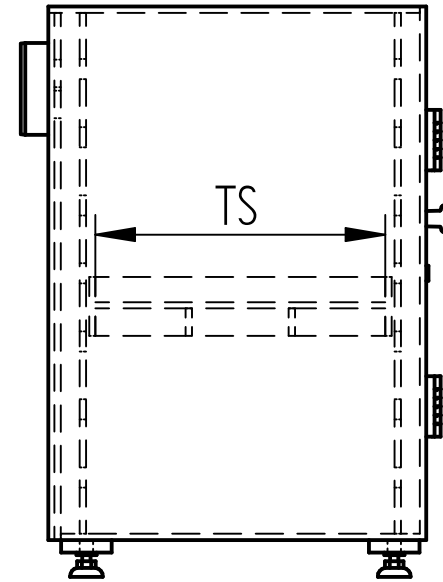
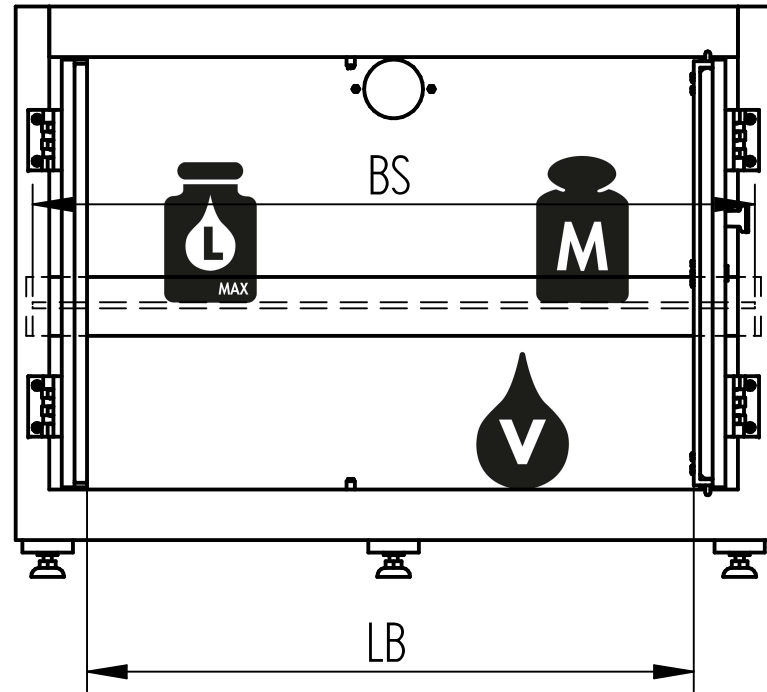

	Model type
	M
BS (mm)	860
TS (mm)	345
M (kg)	30
Max. additional load (kg)	30
L (l)	8
V (l)	16
LB (mm)	722
Number of storage shelves	1
<b>Storage shelves adjustable in 81mm pitch</b>	

BS: Width storage shelf

TS: Depth storage shelf



M: Load bearing capacity per storage shelf (uniformly distributed)

L: Max. volume of the individual container

V: Max. collection volume

LB: Clear width

### Inner dimensions

This drawing is our property! Furnish this information to other persons and reproduce or copy is not permitted without our written permission.	title: Safety cabinet ACID UTS PP		
	drawing no: 000104721	page: 2 of 4	
Düperthal Sicherheitstechnik Frankenstrasse 3 D-63791 Karlstein	revision: 00	date: 2020-03-04	

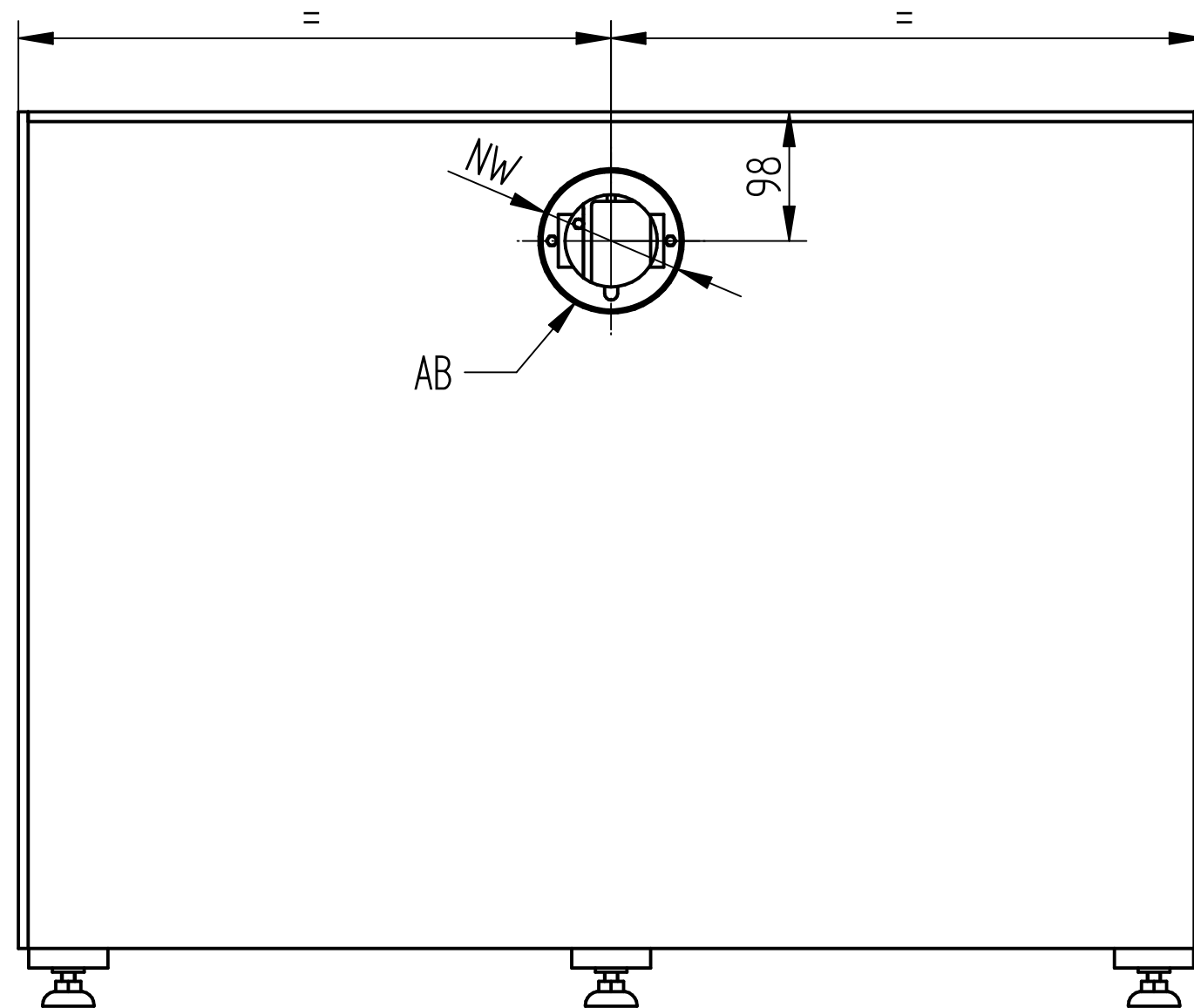

NW: 110, with adapter 75  
 AB: Exhaust air connection

### Ventilation connection

This drawing is our property! Furnish this information to other persons and reproduce or copy is not permitted without our written permission.	title: Safety cabinet ACID UTS PP		
	drawing no: 000104721	page: 3 of 4	
Düperthal Sicherheitstechnik Frankenstrasse 3 D-63791 Karlstein	revision: 00	date: 2020-03-04	

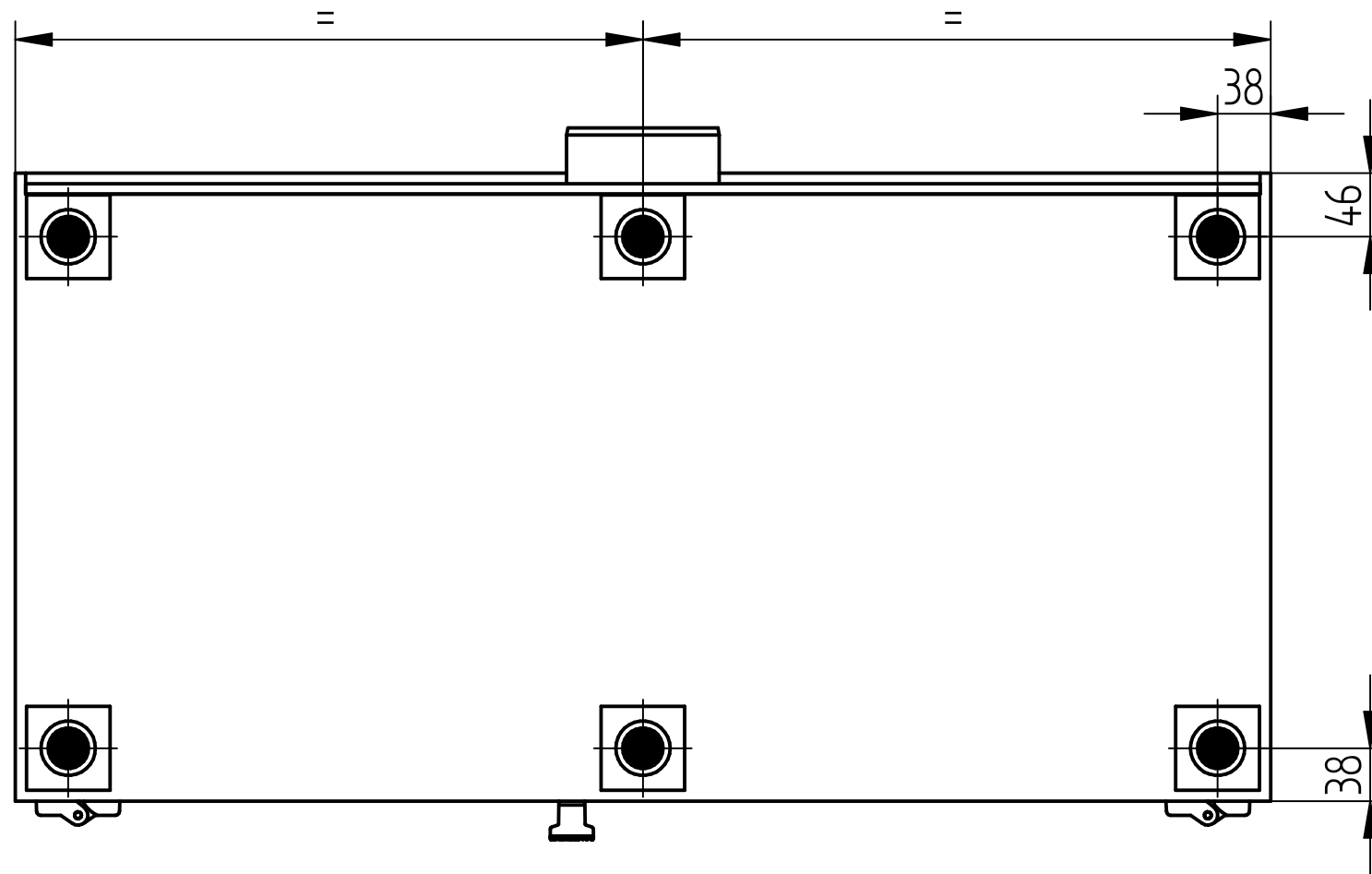

● Loaded footprint

### Geometry of the adjustable feet

This drawing is our property! Furnish this information to other persons and reproduce or copy is not permitted without our written permission.	title: Safety cabinet ACID UTS PP		
	drawing no.: 000104721	page: 4 of 4	
Düperthal Sicherheitstechnik Frankenstrasse 3 D-63791 Karlstein	revision: 00	date: 2020-03-04	
	