

	Model type	
	LL	XL
H (mm)	2045	2045
B (mm)	894	1194
T (mm)	747	612
T1 (mm)	1123	1140
Doors	2	2
Tare weight (kg)	515	565
Inside cabinet volume (m ³)	0,89	0,95

AU / AUV: Exhaust air monitoring unit see page 3

Outer dimensions

This drawing is our property! Furnish this information to other persons and reproduce or copy is not permitted without our written permission.	title: TAP line Type 90, safety cabinet with wing doors		
	drawing no: 000108768	page: 1 of 4	
Düperthal Sicherheitstechnik Frankenstrasse 3 D-63791 Karlstein	revision: 00	date: 2020-11-12	

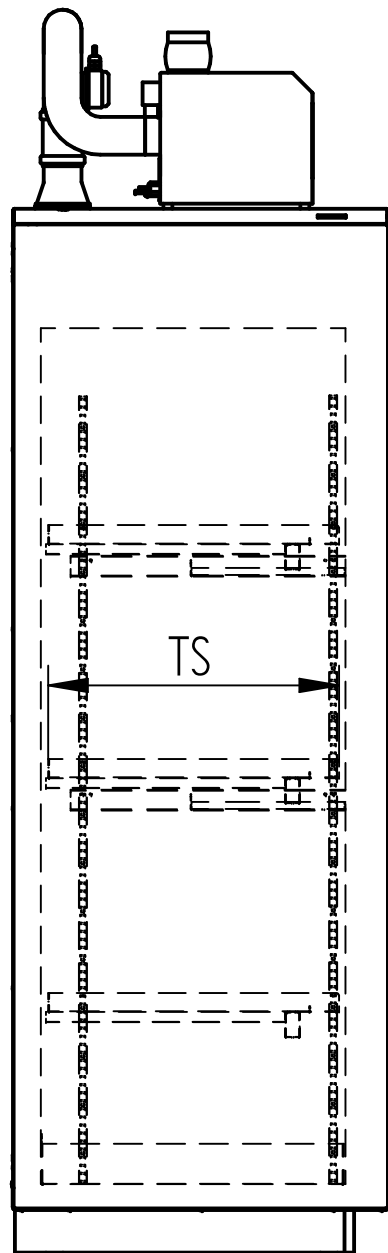
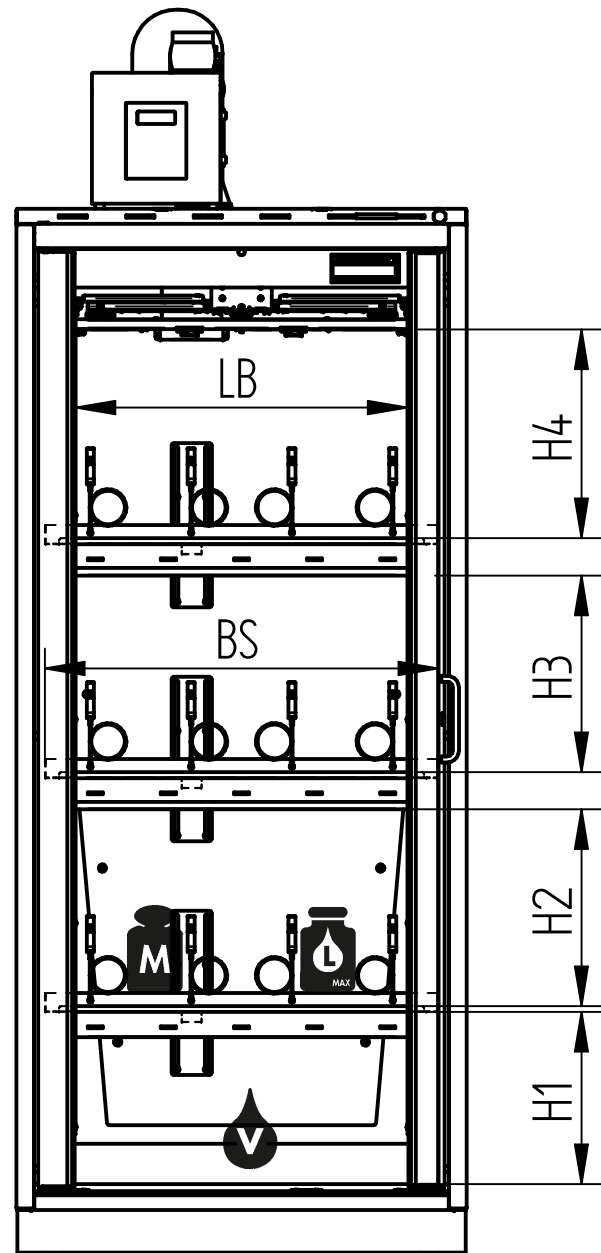

	Model type	
	LL	XL
BS (mm)	777	1077
TS (mm)	517	382
M (kg)	75	75
Max. additional load (kg)	225	225
L (L)	30	30
V (L)	33	33
LB (mm)	674	974

BS: Width storage area
 TS: Depth storage area
 M: Load bearing capacity per storage area (uniformly distributed)
 L: Max. volume of the individual container
 V: Max. collection volume
 LB: Clear width

max. container height (mm)		Model type
		LL, XL
Storage shelves	H1	341
	H2	390
	H3	390
	H4	414

Storage shelves adjustable in 16mm pitch

Inner dimensions

This drawing is our property! Furnish this information to other persons and reproduce or copy is not permitted without our written permission.	title: TAP line Type 90, safety cabinet with wing doors	
	drawing no.: 000108768	page: 2 of 4
Düperthal Sicherheitstechnik Frankenstrasse 3 D-63791 Karlstein	revision: 00	date: 2020-11-12
 DÜPERTHAL		

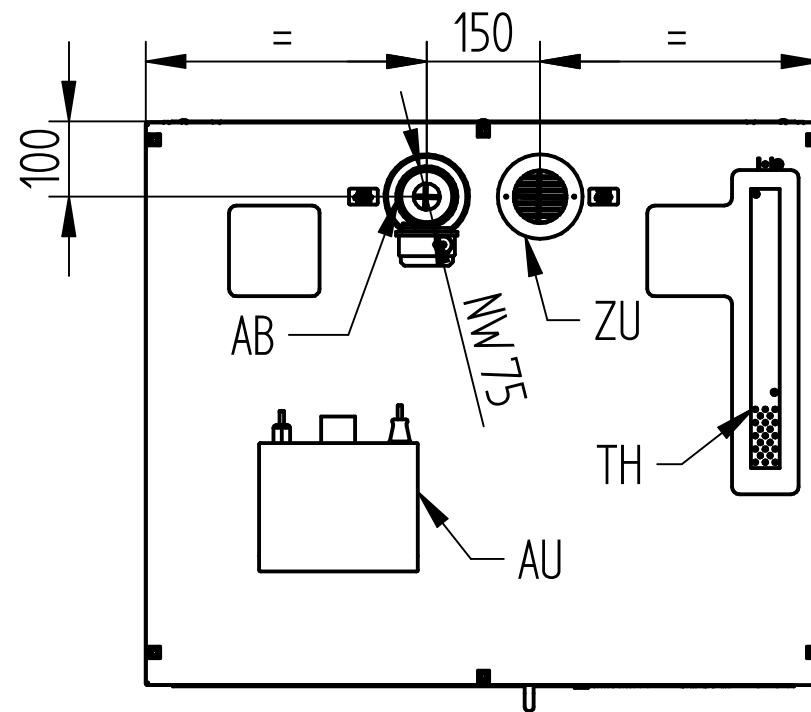
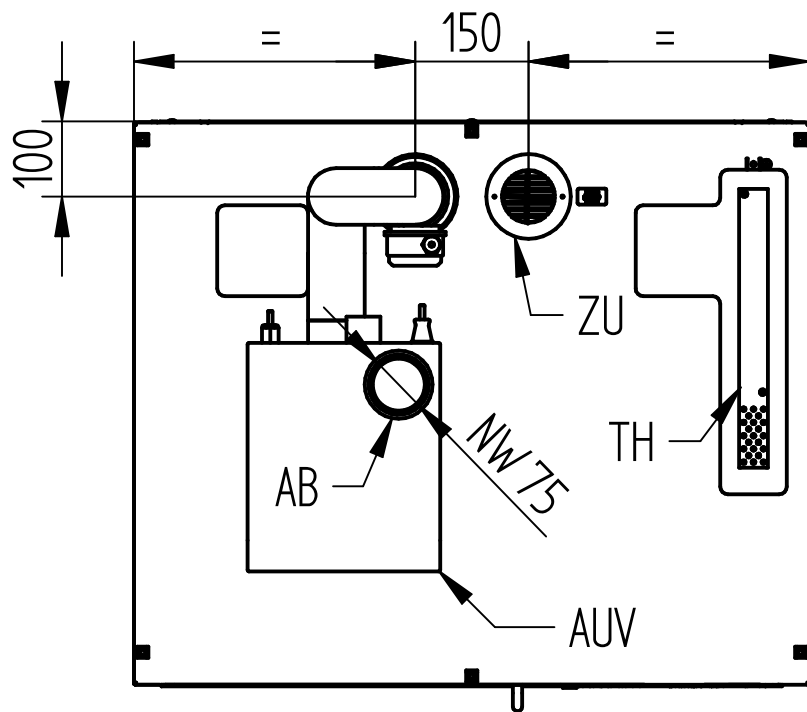
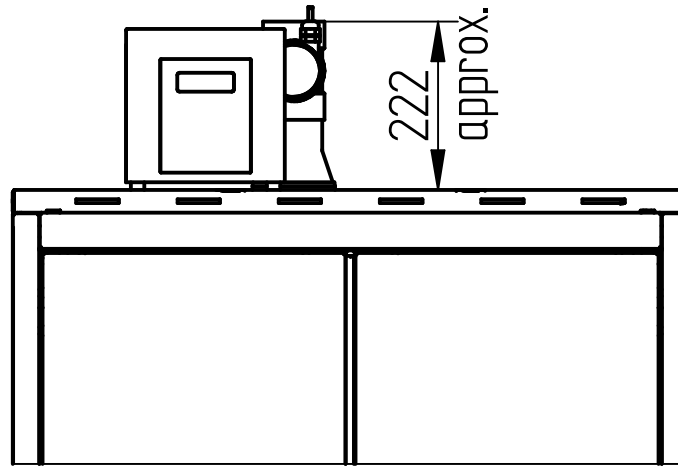
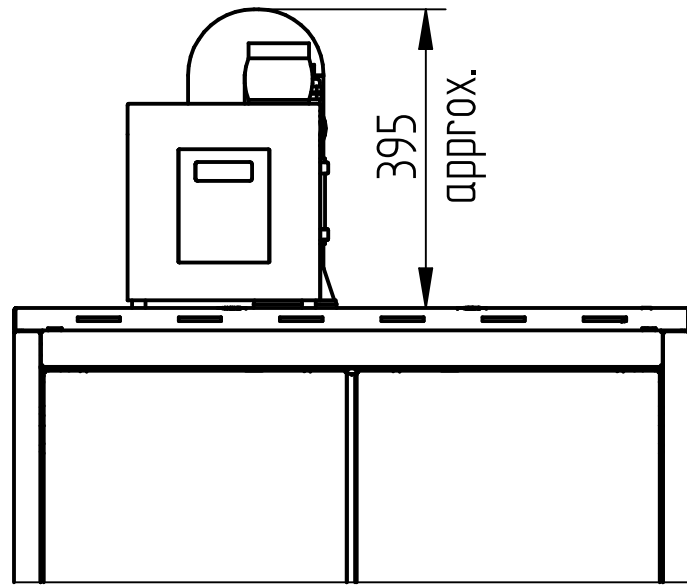



- AB: Exhaust air connection
- ZU: Supply air
- TH: Thermocouple
- AU: Exhaust air monitoring unit
- AUV: Exhaust air monitoring unit with ventilator

Exhaust air monitoring		
	AU	AUV
B (mm)	210	255
T (mm)	210	310
H (mm)	215	275
Power supply cable length approx. (m)	2	2
Sensor cable length approx. (m)	1	1
Exhaust hose length approx. (m)	-	1
Supply voltage (V)	230	230
Supply frequency (Hz)	50	50
plug type	E+F, CEE 7/7	E+F, CEE 7/7

Details on AU / AUV see separate operating instructions

Ventilation connection

This drawing is our property! Furnish this information to other persons and reproduce or copy is not permitted without our written permission.	title: TAP line Type 90, safety cabinet with wing doors		
	drawing no.: 000108768	page: 3 of 4	
Düperthal Sicherheitstechnik Frankenstrasse 3 D-63791 Karlstein	revision: 00	date: 2020-11-12	

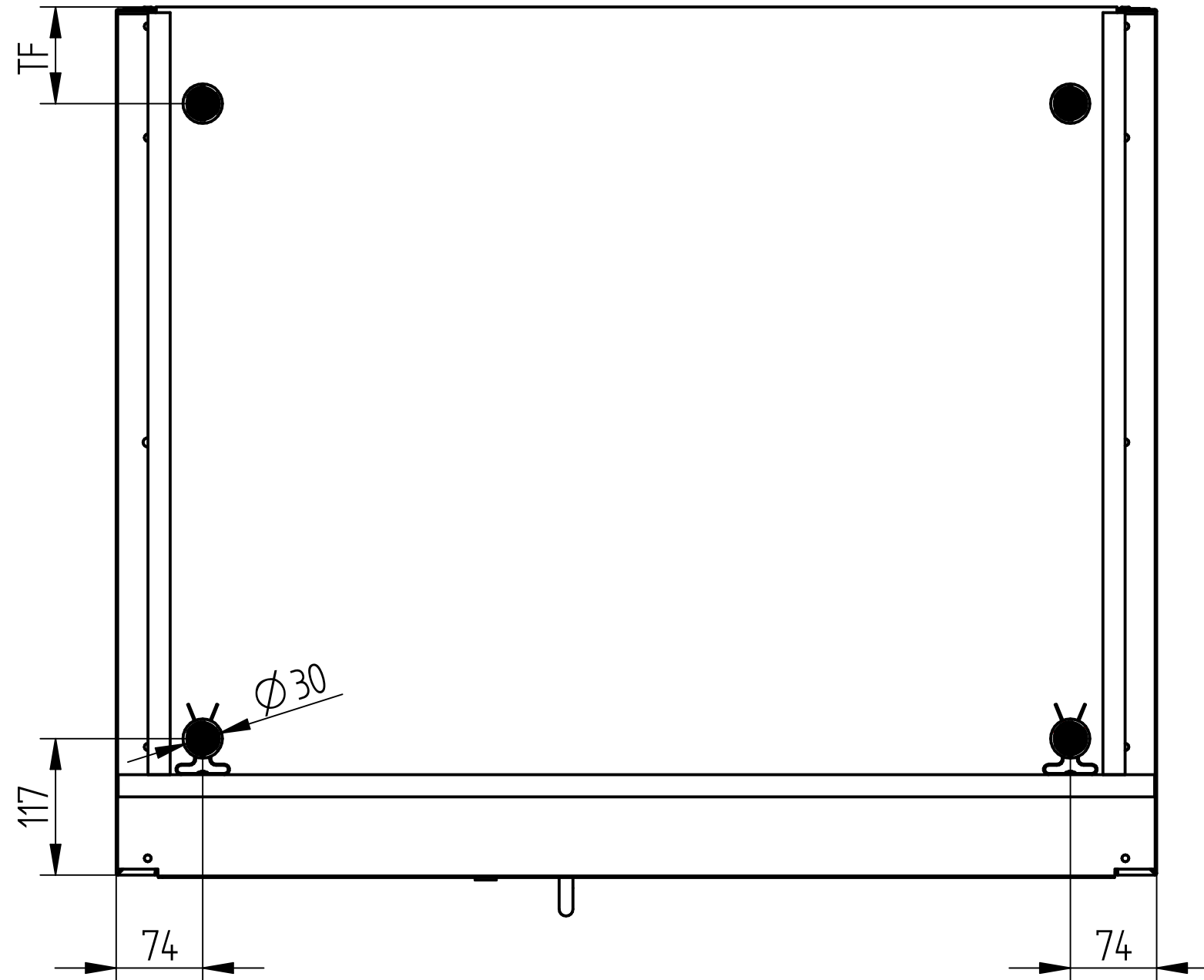

● Loaded footprint

	Model type	
	LL	XL
TF (mm)	83	88

Geometry of the adjustable feet

This drawing is our property! Furnish this information to other persons and reproduce or copy is not permitted without our written permission.	title: TAP line Type 90, safety cabinet with wing doors		
	drawing no.: 000108768	page: 4 of 4	
Düperthal Sicherheitstechnik Frankenstrasse 3 D-63791 Karlstein			